

OCTOBER 1991

# CHICAGO SCENE



The official publication of the Porsche Club of America, Chicago Region

Don't miss Nov. 16 Service  
Clinic and Nov. 17 968 Intro  
Incl. buffet for PCA Members.  
Call Heather for details.

# LFSC



Our Support Truck will  
be at Blackhawk  
Oct. 12 for  
At Track Service.

## PORSCHE®

We are very honored to announce our appointment as the Midwest's newest Porsche dealership. We hope to provide you, the Porsche owner, with the highest level of sales and service attention.

Our new Porsche facility is located in downtown Lake Forest.

The service and parts department will be open 6 days a week for your convenience, not ours. By the way, a grease, oil, and filter change is never more than \$49.95, while you wait!

Enclosed pickup and delivery is available at a minimal charge for those times when you don't have the time. Our trucks and our drivers care about your Porsche as much as you do.

Sales of new and fully warrantied, pristine used Porsches, is open 6 days a week, Wednesday nights until 8:00. Feel free to stop in and browse. We've got a great inventory of Porsches, in the right colors, and the right deal!

Soon we'll be announcing our own track events, service clinics, and SCCA National Porsche Racing Program. We're very serious about Porsche Performance.

So when you think about Porsche and Performance, think about a trip to Lake Forest. You'll be pleasantly surprised. You have our promise.

Thanks,  
Rick

P.S. We have race preparation services available at our 7500 sq. ft. Motorsports Center in Lake Bluff. Call Chas for more information!

Performance Alignments    Driver Coaching    "G" Analyst  
Brake Set Ups    Nut & Bolt Checks    Tire Technology

On-Board Computer Available Soon

With this coupon

Exp. 11/30/91

# 10% Off

Labor Only on any Major Service\*

\*Saturday Service Available

With this coupon

Exp. 11/30/91

# \*20% Off

Porsche Accessories

\*PCA members only, 10% off Porsche list on all parts.

## LAKE FOREST SPORTSCARS BY RICK MANCUSO

Dealership: 708/295-6560  
780 N. Western  
Lake Forest

Motorsports Center: 708/295-5389  
28845 Nagle Court  
Lake Bluff



## "CHICAGO SCENE"

is the monthly publication of the Porsche Club of America, Chicago Region, published at 1628 Southhampton Court, Wheaton, IL 60187. Permission to mail at Second Class rates paid at Wheaton, IL. ISSN 10564195. Subscription is limited to members of The Porsche Club of America, Chicago Region. Porsche Club of America dues are \$36.00 annually, of which \$12.00 is for the subscription to Chicago Scene. Subscription rate for non-members: \$15.00 per year. Permission to reprint any material published herein is granted provided full credit is given to Chicago Scene and to the author. The Porsche Club of America, Chicago Region, is not responsible for any services or merchandise advertised herein. **POSTMASTER:** Send address changes to: Chicago Scene, 1628 Southhampton Court, Wheaton, IL 60187.

**DEADLINE:** Material must be received no later than the 10th of each month for publication in the next issue. Contributions will be published on a space available basis. The editors reserve the right to edit, as necessary, all materials submitted for publication. Statements appearing in Chicago Scene are those of the author and do not constitute an opinion of the Porsche Club of America, Chicago Region, or its Board of Directors.

**MART:** Material should be sent to the editor in accordance with the above deadline. Ads are subject to editing and will run for one month. PCA/Chicago Region members, no charge; non-PCA members or out of region members, \$5.00 per ad. Each ad is limited to 50 words, plus name, address and phone number.

### ADVERTISING RATES:

**Quarter Page:** \$15.00/mo. yearly, \$25.00/mo. quarterly; **Half Page:** \$30.00/mo. yearly, \$40.00/mo. quarterly; **Full Page:** \$60.00/mo. yearly, \$75.00/mo. quarterly.

All requests for advertising space must be made through the editor.

### EDITOR

Doris Voce  
1628 Southhampton Court  
Wheaton, IL 60187  
(708)462-0451  
(708)510-0849 FAX



## OCTOBER 1991 Vol. 34, No. 10

Who's Who	2
The Leed Lane	5
Up & Coming	6
Welcome to New Members	11
The 944 Motor Mount	14
Rear View Mirror	16
Behind the Scenes	21
The Mart	23

**COVER:** Summer's Last Fling: Elkhart II. Photo by John Bohlander

## CHICAGO REGION 1991 CALENDAR OF EVENTS

January 13	Annual Membership Meeting
February 10	Restaurant Tour
March 3	Concours School
March 17	Rallye
April 14	Tech Session
April 21	Concours
May 5	Driving School
May 15	Blackhawk I
May 25 & 26	Elkhart I
June 9	Gymkhana
June 22 & 23	Two Day Rallye
June 30	Restaurant Tour
July 7	Utica Autocross
July 10	Blackhawk II
July 28	Gymkhana
July 28-Aug. 3	Parade
August 11	Potter's Picnic
August 14	Blackhawk III
Aug. 31 & Sept. 1	Elkhart II
Sept. 15	Charity Gymkhana
Sept. 22	Gallagher's Rallye
October 12	Blackhawk IV
October 27	Halloween Concours
November 17	Tech Session
December 7	Dinner Dance

# WHO'S WHO



**PRESIDENT**  
Debby Leed  
(708)382-6911



**VICE PRESIDENT**  
Dan Gallagher  
(312)845-7823



**SECRETARY**  
Chuck Bittman  
(708)246-9505



**TREASURER**  
John O'Keefe  
(708)344-0911



**IMM. PAST PRES.**  
Howard Yefsky  
(312)642-8897



**DIRECTOR**  
Jim Becker  
(708)420-7155

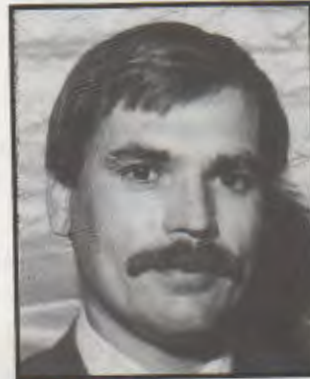

**DIRECTOR**  
Nick Leicht  
(815)338-4854

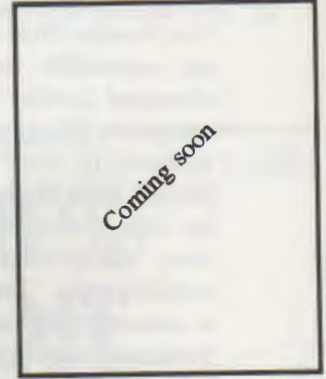

**DIRECTOR**  
Arnold Zann  
(708)386-2864



**DIRECTOR**  
Rip Patterson  
(708)566-2371

## 1991 COORDINATORS

### AUTOCROSS

George Mueller (708)371-0119  
Arnold Zann (708)386-2864

### CONCOURS

Pat Yanahan (708)887-7605

### GOODIE STORE

Linda Patterson (708)566-2371

### RALLYE

Nick Leicht (815)338-4854  
Bruce Janecek (708)361-8421

### SAFETY

Jim Becker (708)420-7155

### SOCIAL

Gail Becker (708)420-7155

### MEMBERSHIP

Lee Lichtenstein (708)577-1550  
24 Hr. Member Info (312)769-8193

### TECH CREW CHIEF

Glenn Sapa (708)690-0667

### "SCENE" EDITOR & ADVERTISING MGR.

Doris Voce (708)462-0451  
FAX(708)510-0849

### PHOTOGRAPHER

John Bohlander (708)963-8076

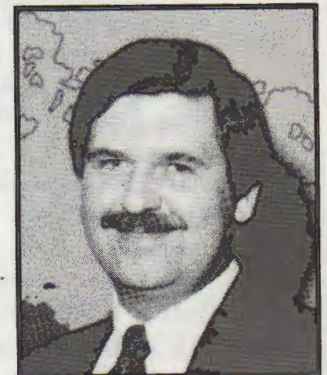

**DIRECTOR**  
Greg Turek  
(708)961-2439

Newsletter printed by:  
GPI Printing, Inc.  
Aurora, Illinois

# Northstar Motorsports Ltd.

## NORTHSTAR MOTORSPORTS LTD.

1099 BROWN STREET, BLDG. NO. 206  
WAUCONDA, IL 60084

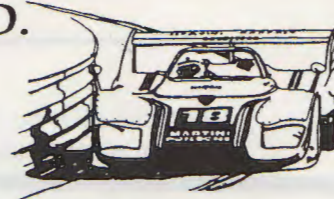

**Porsche®  
Specialists**

- O.E. Parts at Direct Wholesale Prices • Accessories.
- Performance Items • Pyroprotect Driving Suits, Helmets & Equipment.
- Borla & SSI Exhaust Systems • Suspension Systems.
- Restoration Parts - Vintage & Contemporary • MUCH MORE!!
- Bell Helmets, Suits, KAM-LOCK Belt Assemblies.
- Roll Bars, Halon Fire Extinguishers.
- Appraisal Service • Used Porsche® Buyers Advisory.
- Concours Quality Detailing.
- Orders Over \$30 - FREE SHIPPING!!



### 100% STAINLESS STEEL HEAT EXCHANGERS FOR PORSCHE 911

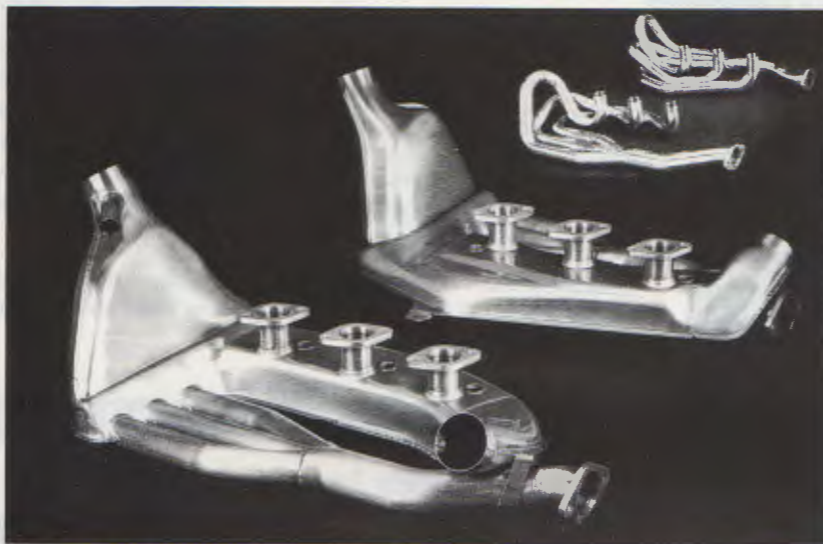

Above: MFI version.

Inset: Headers contained in heat exchangers

- AIRCRAFT QUALITY CONSTRUCTION IN 100% AISI 304 STAINLESS STEEL
- STATE OF THE ART HEADER DESIGN - OUTPERFORMS RACING HEADERS
- ONE PIECE PRIMARY TUBES FOR CARBON MONOXIDE SAFETY
- PRODUCES MORE HEAT, FASTER AND WILL NOT LOOSEN AND RATTLE
- PERFECT FIT - REDUCED INSTALLATION TIME
- TRUE LIFETIME HEAT EXCHANGERS THAT WILL ENHANCE YOUR 911'S VALUE
- QUALITY THAT WILL REKINDLE YOUR PRIDE IN AMERICAN MADE PRODUCTS
- RETROFITTABLE TO ALL 2, 7, 3.0 & 3.2 911'S FOR INCREASED POWER OUTPUT\*
- AVAILABLE THROUGH :

#### CONSUMER WARNING

It is common in the exhaust aftermarket for some manufacturers and marketers to use deceptive and often false claims of quality, safety, and unrealizable power gains to promote their products. For example; one of our competitors claims to use thick tubes for CO safety "just like Porsche," when in fact the factory abandoned that design in 1968 for safety reasons. Another claims 25 H.P. gain with their SC muffler, when in reality, you *might* get 2 H.P. Beware of "Original" heat exchangers for less than list price; you will get a carbon steel counterfeit with a phony Porsche sticker. We recommend you see the products before you buy, or at least demand a return privilege. Above all, EDUCATE yourself before you buy. Bruce Anderson's article, "911 Exhaust Systems" in the Jan., 1987 Porsche Panorama is a good place to start.

*Northstar Motorsports*

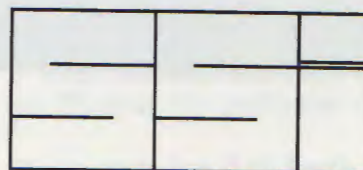

M-F: 9-5  
Sat & Evenings: Available by  
Appointment



**CALL NOW**  
**1-800-356-2080**

**When The Bottom Line Counts As Much  
As The Red Line...  
Count On Bill Jacobs  
Motorsport.**



Winner of the Exclusive  
Porsche Premier Award  
For Service Excellence,  
Customer Satisfaction  
& Sales Performance



The Bill Jacobs Motorsport Bottom Line pricing policy can put you behind the wheel of the finest European new and pre-owned performance vehicles at considerably less than you may think. And when it comes to keeping your Porsche in peak performance condition, our 40 years of experience is certain to satisfy even the most finicky Porsche enthusiast.

Plus as a PCA member Bill Jacobs Motorsport offers a 15% discount off the retail price on any over the counter parts and accessories.

**Bill Jacobs Motorsport**

1564 W. Ogden Ave. • (708) 357-1200

**NAPERVILLE**

Call 1-800-B-JACOBS

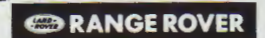

---

## THE LEED LANE

---

The most important page to read in this issue of the *Scene* is the ballot for the officers and directors for 1992. Again this year, for your convenience, we have made the ballot a loose piece of paper. All you have to do is read it, vote, fold the sheet and mail it to Chuck Bittman. His address is on the back of the ballot. You only need a stamp! There were no candidates by petition this year but there is room for write-in candidates. Don't leave the voting up to the next guy - VOTE!

On September 16th Dan Gallagher reported that Blackhawk IV (Saturday, October 12th) is already half sold out. Chef Karl from the Edelweiss Restaurant will be catering dinner. If you don't want to miss the last chance this season to drive your Porsche and you don't want to miss a fun filled evening, call Dan today.

Our annual fall concours will be held Sunday, October 27th, at Bill Jacobs Motorsport. Again this year we are challenging the members of the Windy City Region of the BMW Club to a q-tip showdown. May the best team win! Jacobs is graciously providing us food and beverage but they need a head count to plan the amount needed. Please RSVP to Bonnie or Pat Yanahan even if you're not concouring.

Rumor has it that part of our 35th anniversary party will include a concours. Pass the word.

Love to drive your Porsche? Does traveling to exotic, far away places and some not-so-far-away places sound good to you? Like meeting new people? Love the Porsche Club? I have just the thing for you! Steve Southard, our current Zone 4 Representative, will be completing his term at the end of the year and he has decided not to seek another appointment. If any of you want to take on the responsibilities of Zone Rep or you know someone in Chicago Region who does, or someone in another Region who is interested, please call me by October 31st.

I'm sure you don't look for your name in the directory very often but please take a minute to check your address and home and business phone numbers. We make every effort to accurately update the database on a monthly basis in preparation for the new directory. We receive many address changes via the post office but we need phone number changes from you. Please write to me or call with your changes.

See you soon!

Debby

### **Don't Renew Your Insurance...**

**Until you get a cost and coverage comparison from JAMES CADY AGENCY of FARMERS INSURANCE GROUP**

JAMES CADY, representing Farmers Insurance Group for 25 years, the Nations THIRD largest insurer of Autos and Homes.

Free... Road Atlas or Needle Kit with any quotation in our office or your home.



**JAMES CADY AGENCY**  
525 W. Higgins (at Golf)  
Hoffman Estates, IL 60195

**490-1200**

**Auto, Home, Life, Commercial, Renters, Condo-Owners, Cycles, Boat, Etc...**

Auto/Home combination discount on BOTH.

Preferred risks between the ages of 25 and 69 get lower rates.

Discounts for Anti-Lock Brakes, Non-Smokers, Driver's Ed, Good Students and Drivers over 50, etc..

---

# UP & COMING

---

## TECH SESSION

**November 16th & 17th  
Lake Forest Sports Cars**

This fall's Tech Session will be especially spectacular. Our normal one day affair has been expanded into two. Chicagoland's newest Porsche dealer, Rick Mancuso's Lake Forest Sports Cars, has graciously agreed to host this event.

Saturday from 9 AM to 3 PM the dealership will hold a Service Clinic with mechanics and Porsche personnel there for a free inspection of your car and to answer specific questions.

On Sunday, LFSC will host a buffet brunch from Noon to 5 PM with the spotlight on the unveiling of the brand new 1992 Porsche 968. You must be there for this once in a lifetime event.

Call Glenn Sapa at (708)955-0357 Ext. 103 to register. Please leave a voice mail message if I'm not there.

## HOLIDAY PARTY

Mark your calendars now for our once a year opportunity to dress up in all our holiday finery and enjoy an evening of great fun, good food, and some kick-up-your-heels music at our Annual Holiday Party and Awards Celebration.

This year's dinner dance will be held on Saturday, December 7th, at the OakBrook Bath and Tennis Club, the same location as last year's, and promises to be a fun evening.

Further details and a registration form will be in the November *Scene*.

## NOVEMBER BRUNCH CANCELLATION

Please note that the brunch originally scheduled for November 10th had to be cancelled due to logistic problems. Let's have a double celebration at the Holiday Party instead!

**Paul's**

**Auto Restorations Today**

**Personal One-On-One Service**



**(708)690-4487**

**23W755 North Avenue, Carol Stream, IL 60188**

 **swiss  
precision**

## AUTO DETAILING SPECIALISTS

FOR THOSE WHO DEMAND ONLY THE BEST CARE FOR THEIR MOTORCAR, SWISS PRECISION CAN ACCENTUATE ITS INHERENT BEAUTY WITH OUR HOLISTIC APPROACH THE SWISS WAY!!! ABSOLUTE PERFECTION

### OUR STANDARD SERVICE INCLUDES:

Hand wash and dry  
Engine steam clean and detail  
Glass cleaned  
Tire and rim scrub  
Hand polish, wax & buff  
Chrome treatment

Interior scrub (seats, dash, door panels & console)  
Leather & vinyl conditioning  
Carpet shampoo & Scotch<sup>®</sup> Guard<sub>TM</sub> application  
Free pickup & delivery within city limits



---

2025 W. Grand Avenue—Chicago, IL 60612  
312-738-2074—Fax: 312-733-4759

---

## **BLACKHAWK OCTOBERFEST**

**DATE:** October 12, 1991 **SATURDAY**

**TIME:** 8 AM - 5 PM Registration closes at 11 AM

**PLACE:** Blackhawk Farms Raceway, South Beloit, WI

Repeated by popular demand - our Second Annual Blackhawk Octoberfest! Now is your chance for a last high-speed event before the Porsches go into hibernation for the winter.

Blackhawk Farms Raceway is an eight turn 1.8 mile track located just outside Rockton, Illinois, conveniently close to the Northwest Tollway. Please note that at these events we allow cars other than Porsches to participate. We are not suggesting that you bring up the family station wagon, but sports cars and sporting type cars that pass tech will be permitted.

The entrants for this event will be divided into four classes so that slower cars and/or novice drivers will not be on the track at the same time as the faster cars. While we will have four classes at this event, instead of the usual three that we have at our other Blackhawk events, all classes will have a total of two hours track-time. As always, keep in mind that the club's insurance requires all drivers to wear long sleeved cotton shirts, long pants, and a helmet at all times while on the track.

Following the close of the track at 5 PM, we will be treated to an Octoberfest Dinner at the track pavilion by Chef Karl Beckmann of The Edelweiss Inn in Libertyville. The dinner will include beer and wine, steak and baked chicken for the adults; coke and 7-Up, bratwurst and chicken for the children, all at the amazingly low cost of \$17.50 each for adults, and \$8.50 each for the children. Chef Karl is well known for his terrific cooking and his charming German manner, so it promises to be a great way to cap off the day at the track. To put us in a festive mood, Karl will even provide us with German background music! What a guy!

Since we expect a record turn-out for this event, be sure to send your registrations in early so we will know how many to plan for. Plan now to bring your family and friends for a lovely autumn day and evening at Blackhawk.

### **Directions to Blackhawk:**

Northwest Tollway (I90) North to IL 75 (just South of the Wisconsin line), West on 75 to T (Blackhawk Road), right to Shirland, left on Shirland to Fischer, left on Fischer to T (Prairie), left about 1/4 mile to track entrance on right.

Dear Dan:

We want a last chance at Blackhawk!

Name \_\_\_\_\_

Member \_\_\_\_\_ Applicant \_\_\_\_\_ Guest \_\_\_\_\_

Car: Make \_\_\_\_\_ Model \_\_\_\_\_

Driver: Experienced \_\_\_\_\_ Novice \_\_\_\_\_

Cost: \$80.00 Preregistered; \$85.00 late registration

No charge for family or affiliate member as second driver.

Blackhawk Pre-registration \_\_\_\_\_

\_\_\_\_\_ adult dinners @ \$17.50 ea. \_\_\_\_\_

\_\_\_\_\_ childrens dinners @ \$8.50 ea. \_\_\_\_\_

Make checks payable to PCA/Chicago Region and mail to:  
Dan Gallagher, 360 East Randolph Street, Chicago IL 60601

Questions?? (312)616-1416

EMMONS

# COACHWORKS

L I M I T E D  
FINE MOTORING ACCESSORIES

"A candy store for anyone who loves cars"

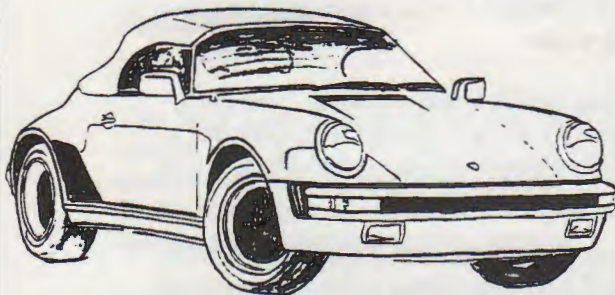

CAR COVERS • RADAR DETECTORS  
CLEANING SUPPLIES • CLOTHING • BOOKS • ROOF RACKS  
SHEEPSKIN PRODUCTS • MODELS • LEATHER GOODS • WHEELS  
SUNGLASSES • SPOILERS • HEADLIGHT COVERS • FLASHLIGHTS  
FLOOR MATS • SEATS • STEERING WHEELS

THE COURTYARD  
100 EAST ROOSEVELT ROAD  
VILLA PARK, IL  
(708) 832-1411

\* CALL FOR PRODUCT LISTING



## USED PORSCHE PARTS

Largest Used Parts Inventory in the Midwest  
Everything for your 914 and 924  
No Part too Small

(Also a limited number of 356, 911/12, 928, 930 & 944 Parts)

**FREE** PORSCHE KEYCHAIN WITH  
AN ORDER OF \$10 OR MORE

UNCONDITIONAL 30 DAY  
MONEY BACK GUARANTEE

## PART WERKS OF CHICAGO

312-472-1096

WE BUY PARTS CARS



## SPECIALIZING IN PORSCHE CONVERSIONS

SLANT NOSE & WIDE BODY  
CONVERSIONS,  
CUSTOM BRAKE VENTS,  
BOXED ROCKERS.

856 Liberty Drive, Libertyville, IL 60048

708/367-8707

FAX  
708/816-0490

**MINTEX**  
brake pads

HIGH  
PERFORMANCE  
RANGE

**BRAKE LIMIT** - the original supplier of race proven **MINTEX HIGH PERFORMANCE BRAKE PADS** for your Porsche now also offers Performance Friction racing pads.

**MINTEX**, a pad developed for the European Racing Circuit, has superior wear characteristics, works well when cold, is easy on your rotors, and provides superb and consistent braking performance throughout the temperature range.

Move up to **MINTEX!**

Or, if you have one of those high speed 911 or 944 Turbos, or a car equipped with Wilwood calipers, you may want to try Performance Friction Carbon Fiber Metallic racing pads - the latest in racing technology. These pads are used on Nissan and 962 GTP cars.

Ask about 944 Turbo Cup parts including 8 & 9 x 16 magnesium racing wheels. Also AP550 brake fluid.

Brake Limit, the ultimate in stopping power, eves. 708/438-7813

**PERFORMANCE  
FRICTION** Carbon  
Metallic

# PORSCHE-BMW CONCOURS

The last concours of the year will be a two-club contest. Not only will we have our regular Chicago PCA four class concours, the BMW folks will have theirs and then we will have a showdown between the two clubs. We thought we would invite them to show how Porsche people take care of their cars.

## THE BILL JACOBS MOTORSPORT FOURTH ANNUAL FALL CLASSIC CONCOURS

**Date:** October 27, 1991

**Location:** Bill Jacobs MotorSport, Ogden Avenue in Naperville, East of Route 59 and West of Route 53. The landmark is the big Nabisco Bakery directly across the street.

**Time:** Concours entrants may arrive at 10:00 AM and judging and other events will start at 1:00 PM sharp.

**Cost:** \$10.00 to concours entrants who must pre-register. Other activities, buffet and light refreshments are compliments of Bill Jacobs MotorSport but, also register so we can give our host a count for refreshments.

### CONCOURS - SERIOUS AND STREET

We will use the inside showroom and garage facilities for the standard Chicago Region PCA Classes A, B, C, and D. Trophies will be awarded to members in these categories, but, of course, non-members and applicants are welcome to participate in these classes.

The BMW Club will have their concours classes and then we will match the winners with trophies going to best of show. If you own one of each brand - bring them both. Overflow will go outside if necessary.

Porsche and BMW master mechanics from Bill Jacobs will be in the garage to answer any and all technical questions, and Vince Butera, who is their Director of Service, has consented to be a Concours Judge again this year.

We will have some planned activities for the kids and a radio controlled car racing event set up in the back parking lot away from the traffic.

To aid our host in planning for this event, we need concours registration ahead of time and a phone call from you to tell us how many adults and how many kids are coming, so that we can plan for food accordingly.

Be sure to invite other Porsche (and BMW) people to come to meet our members.

### REMEMBER - CONCOURS PREREGISTRATION IS REQUIRED

---

### REGISTRATION OCTOBER 27, 1991 FALL CLASSIC CONCOURS

Name \_\_\_\_\_ Member \_\_\_\_\_ Applicant \_\_\_\_\_ Guest \_\_\_\_\_

\$10.00 for Car Entries Only

Checks payable to PCA/Chicago Region

Concours Class: A \_\_\_\_\_ B \_\_\_\_\_ C \_\_\_\_\_ D \_\_\_\_\_

Mail to: Pat & Bonnie Yanahan, 7754 S. County Line Road, Burr Ridge, IL 60521

Call with any questions: (Home) (708)887-7605 (Office) (312)444-9570 (Fax) (312)444-9426

Number of Adults \_\_\_\_\_ Number of Kids \_\_\_\_\_

**PLEASE TELL US HOW MANY ARE COMING FOR PLANNING BY OUR HOST!**

THE LAW OFFICES OF  
**KENDRICK SCOTT, LTD.**

21 NORTH SKOKIE HIGHWAY  
LAKE BLUFF, ILLINOIS 60044  
(708)234-6680

**KENDRICK SCOTT**  
ATTORNEY AT LAW



**"It's mid-life crisis related. He hurt his back trying to get into a Porsche."**

# midwest EUROSPORT

Committed to excellence, MIDWEST EUROSPORT specializes in the maintenance, repair and performance tuning of fine European automobiles. With emphasis on Mercedes-Benz and Porsche cars, our professional mechanics have been expertly trained by the European manufacturers. Using only state-of-the-art diagnostic equipment and genuine parts, our work is satisfaction guaranteed. And, as a Bosch Service Center we will provide reliable service on your car's advanced fuel injection, ignition and brake system. Whether it's minor maintenance or an engine overhaul, MIDWEST EUROSPORT is your best source for quality, service and value.

- **ANDIAL 3.4 Conversions**
  - **BOSCH 4-wheel alignment**
  - **Weltmeister Suspensions**
  - **K27-Turbo's**
  - **Alloy wheel polishing**
  - **Sport exhaust systems**
  - **Custom accessories**
- and more...  
**MUCH MORE!**

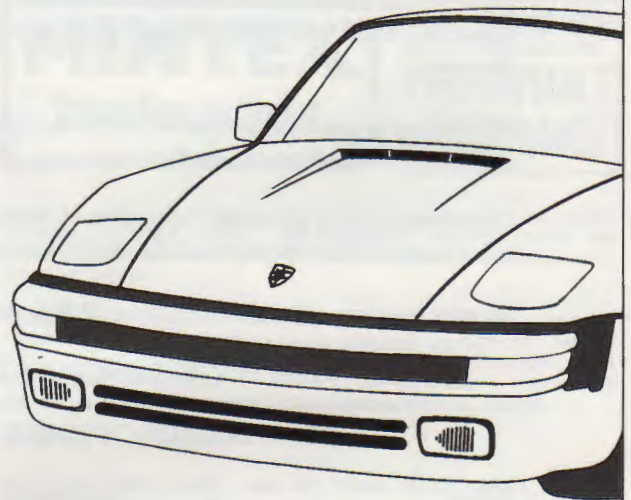

**Bosch  
Authorized  
Service**

Visit our new, spacious location  
104 W. Irving Park Road, Bensenville

**708/595-5577**

*(Just 1 block west of York Road on the S/W corner of  
Irving Park and Center Street)*

---

# WELCOME

---

## TO OUR NEW MEMBERS

By Lee Lichtenstein

James & Nancy Herold  
1255 W. Byron  
Addison, IL 60101  
1988 911

Jim Jr. & Patricia Jacisin  
336 East End  
Hillside, IL 60162  
1989 944

Ron & Sandy Jezl  
102 W. 64th Lake Drive  
Westmont, IL 60150  
1984 911

Paul Kijak  
214 Pondridge  
Libertyville, IL 60048  
Associate Member

Robert Mayberry  
475 Hampshire  
Elmhurst, IL 60120  
1971 911E

Randy & Christine Sanecki  
208 Iris Drive  
Streamwood, IL 60107  
1972 911T

Dennis Wiesnoski  
2212 N. Racine #2F  
Chicago, IL 60614  
1967 911

Elrick Williams  
312 N. May #5A  
Chicago, IL 60607  
1974 Carrera

## TRANSFERS IN FROM OTHER REGIONS:

From Western Michigan:  
Bruce & Connie Jorgensen  
102 E. Timbercreek  
Yorkville, IL 60560  
1968 911L

From Eastern Buckeye:

Charles Knox  
P.O. Box 957005  
Hoffman Estates, IL 60195  
1988 944

From Western Michigan:

Dalie Thomas  
2736 Downing Court  
Aurora, IL 60504  
1981 911SC

From Mardi Gras:

Lucian & Carolyn Truscott  
431 W. Roscoe, Apt. 12A  
Chicago, IL 60657  
1989 944S2

## MOTORSPORT DETAILING

- Specializes In Polishing and Preparing The Finest Sports cars In The World.
- Car Wash, Detail and monthly maintenance programs.
- Pickup and delivery of your vehicle and flat-bed service available.
- Sports car and racing accessories are available.

YEAR ROUND STORAGE AVAILABLE

102 West Skokie Valley Road  
Lake Bluff, IL 60044  
(708)615-0707

# Porsche Teamwerk,

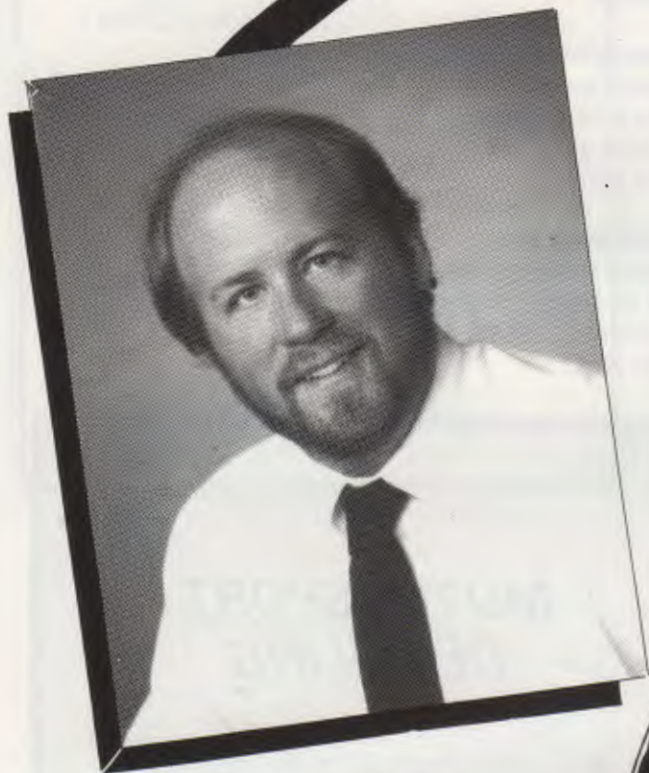

**Jim Mueller**  
Motor Werks Porsche  
Service Consultant

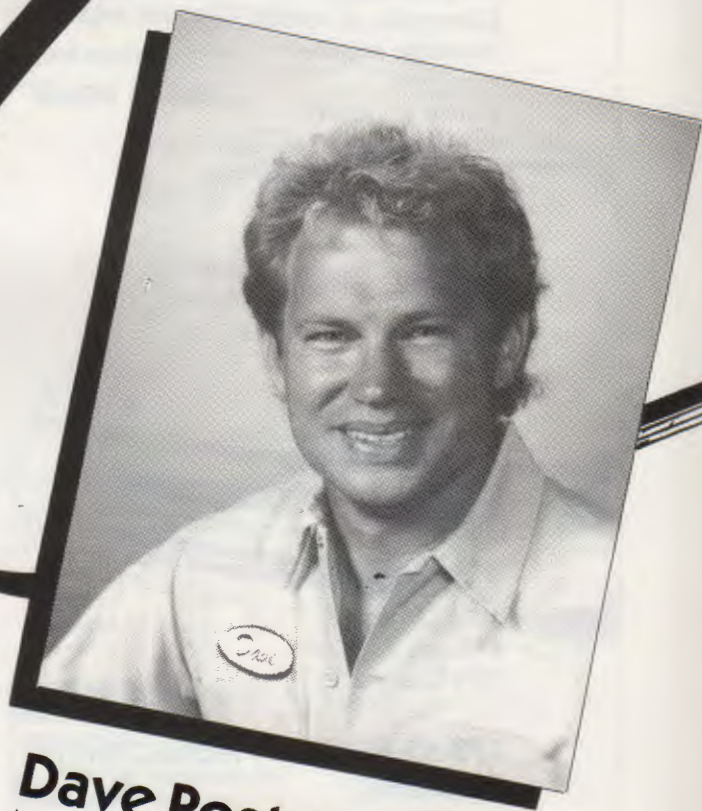

**Dave Posten**  
Motor Werks Porsche Lead Technician  
(One of only two Porsche Master  
Technicians in the country)

# Motor Werks Style

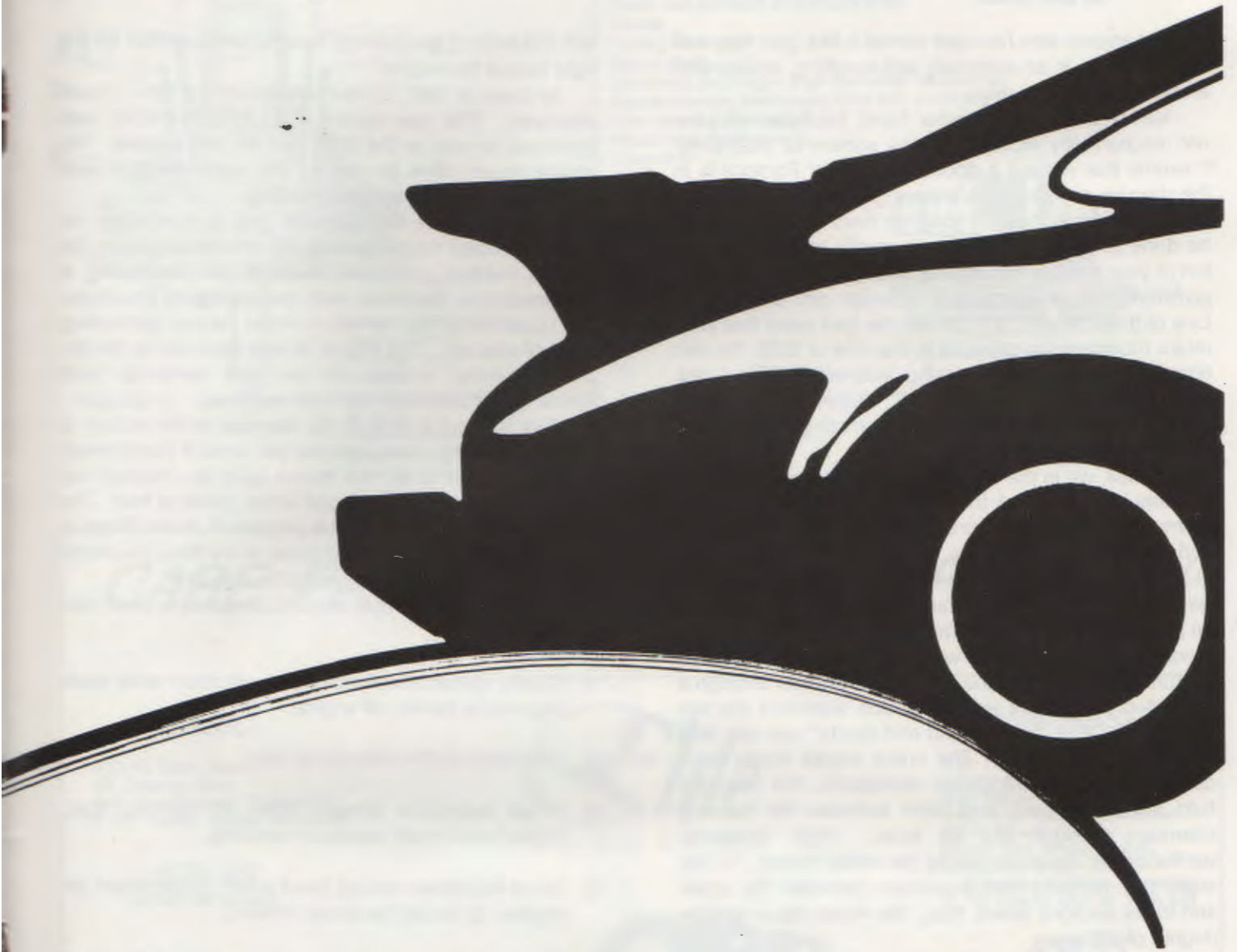

**New Midnight Service Hours • Call 708/304-4580 for your appointment**

**Sales • Service • Leasing • Finance • Insurance • Accessory Boutique**  
Barrington Road & Dundee Road • Barrington, Illinois  
Phone: 708/381-8900 • Mall Hours: Daily 9 to 9. Sat 9 to 6  
Service & Parts Department: Mon thru Fri 7AM to Midnight

---

# THE 944 MOTOR MOUNT - MYTHS, MYSTERY AND MAGIC!

---

By Lee Wister

For anyone who has ever owned a 944, you may well know that this is an extremely well-handling, economical and enjoyable car to drive.

Maintenance, on the other hand, for those who are not mechanically inclined, can be somewhat frustrating. It seems that without a doubt, when your Porsche is in the shop for servicing, you always get the phone call from the service advisor telling you that there is more work to be done to your car. This fact usually translates into a ton of your hard-earned money and an explanation of the problems that only a rocket scientist can understand. One of these problems is usually the bad news that your motor mounts need attention to the tune of \$500. By this time, you are probably asking yourself, "Didn't I just replace that darn thing last year?" Hopefully, this article will shed some light on the matter by tracing the evolution of the 944 motor mount.

In 1983, we in the U.S., saw the 944 for the first time. In many ways this was the evolution of the 924 but with many new design features, one of which was the hydraulic motor mount (see fig. 1). The mount consists of an elastic hollow member which had mounting flanges on each end. The entire center of the mount is filled with an alcohol/water mixture. The hollow chamber inside the mount is divided into two working chambers. The fluid mixture is moved from one chamber to another through a calibrated bore in the jet plate which separates the two chambers. "Well, that's all find and dandy," you say, "but how does that work?" The entire mount works as a damper. For low frequency oscillations, the damping fluid will move back and forth between the working chambers through the jet bore. High frequency oscillation will be absorbed by the entire mount. In this state, the damping fluid movement between the upper and lower sections slows, thus, the mount has a greater degree of stiffness.

If any of you are still with me, you may have a promising career as a mechanical engineer.

In August of 1984 the mount was changed (P/N 944.375.042.02) to increase life expectancy by resisting higher ambient temperatures. This was done by changing the rubber compound, damping characteristics and liquid of the hydraulic mount.

The addition of a 4mm spacer between the top of the mount and the left engine mounting bracket as well as the modification of the lower engine cover were made to increase airflow, and thus cooling, of the mount. These mounts were painted grey in color.

The next change was to occur with the introduction of the 1986 944 Turbo. These mounts (P/N

951.375.042.01) are orange in color and located on the right side of the engine.

In June of 1987, a new version of the turbo mount appeared. This new mount (P/N 951.375.042.05) was approved for use on the 924S and the 944 models. The engine mount arms as well as the cross member were further modified for increased cooling.

The 1989 944 S2 Cabriolet got a completely redesigned motor mount (see fig. 2). In comparison to the mounts installed previously, there is now decoupling of high frequency oscillation with low oscillation amplitude. The upper mounting surface is 4mm thicker, eliminating need of spacers. The mount is now fastened to the engine mounting bracket by two self centering bolts (formerly two bolts with nuts and washers).

This is a quick look at the changes in the history of the motor mount. Now, how do you know if yours needs attention? First of all, the mount can't be checked out 100 percent. It's not black and white, good or bad. The question is: "Does it do its job properly?" If the fillings in your teeth are being vibrated loose every time you come to a stop, the odds are it needs to be checked!

Here are some simple ways to diagnose a weak motor mount:

- 1) Clearly discernible knocking or vibration while starting and/or turning off engine.
- 2) Excessive engine vibration at idle.
- 3) Visual inspection showing leaks of damping fluid, rubber peeling off, cracks or notching.
- 4) No or insufficient spring travel when pulling down on engine. (It should be about 2-3mm.)

The most accurate way to make the call is by measuring the installed height of the mount in your car. This can be done by making a simple tool to check this distance. First, take a piece of wire coat hanger or welding rod about 85mm long. Make a 90 degree bend approximately 9mm from one end of the rod. Make another 90 degree bend in the same direction, approximately 15mm from the other end of the rod. Now, adjust the two bent ends until they are 60mm apart.

After you have completed the fabrication of your high-tech tool, here is how to use it!

- 1) The short leg of the check gauge is placed between the cross member and the mount.

- 2) The long leg of the check gauge will indicate the minimum setting height of the upper contact surface (top of the mount).
- 3) The mount is defective if the setting dimension is less than 60mm.

I hope this brief article will give you a better understanding of details and operation of the 944 motor mount.



[Reprinted from San Diego Region's Windblown Witness]

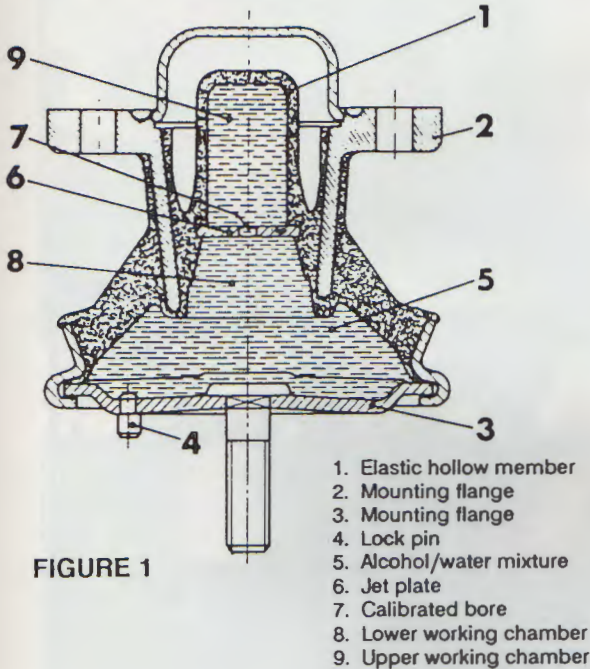
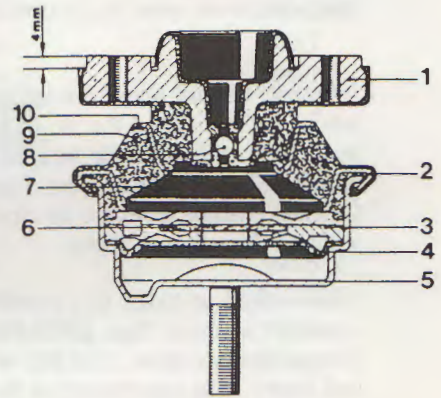

FIGURE 1

1. Elastic hollow member
2. Mounting flange
3. Mounting flange
4. Lock pin
5. Alcohol/water mixture
6. Jet plate
7. Calibrated bore
8. Lower working chamber
9. Upper working chamber

1. Mount flange
2. Outer race (crimped over mount shell)
3. Nozzle
4. Rolling diaphragm
5. Mount shell
6. Oscillating diaphragm (high frequency decoupling)
7. Mount chamber (completely filled with absorbing fluid)
8. Filler opening (tapered plug)
9. Mount core (load-carrier)
10. Connector

FIGURE 2



# CARE PACKAGES FOR YOUR CAR !!

FEATURING MEGUIAR'S PRODUCTS

## BASIC

#00 Hi Tech Wash  
#6 Cleaner Wax  
#40 Vinyl/Rubber Treatment  
3 1/2 Gallon Bucket With Lid

**\$24.95**  
(A \$29.85 Value!)

## ENTHUSIAST

#00 Hi Tech Wash  
#6 Cleaner Wax  
#40 Vinyl/Rubber Treatment  
P21S Wheel Cleaner  
Super Soft Wheel Brush  
3 1/2 Gallon Bucket With Lid

**\$39.95**  
(A \$50.75 Value!)



## CONNOISSEUR

#00 Hi Tech Wash  
#7 or #9 Polish  
#26 Yellow Wax  
#40 Vinyl/Rubber Treatment  
P21S Wheel Cleaner  
Super Soft Wheel Brush  
Sheepskin Wash Mitt or  
Absorber Artificial Chamois  
3 1/2 Gallon Bucket With Lid

**\$59.95**  
(A \$77.65 Value!)



Elite Motoring has a complete selection of car care products and fine accessories and offers a 10% discount on regularly priced merchandise to all car club members!

ELITE MOTORING ACCESSORIES / WOODFIELD MALL / (708) 330-0054

---

# REAR VIEW MIRROR

---

## POTTER'S PICNIC & CONOURS

### Picnic....

*'pik-(')nik : an outing with food usually provided by members of the group and eaten in the open : a pleasant, carefree, experience*

John and I heard about the infamous Potter's Picnic when we first joined P.C.A. in Minneapolis. Rumor had it that Potter's Picnic, next to the Porsche Parade, was the oldest Porsche event. Fortunately, a move to Chicago enabled us to see *up close and personal* just what all the talk was about.

When asked to judge this event, we jumped at the chance. Two huge flags greeted us as we drove up to Wayne Potter's farm. The day was glorious - warm and sunny. The cars entered in the concour seemed to glisten in the distance - a car buffs dream! There were people everywhere - this was no little picnic!

John and I were assigned to the novice or first time Q-tip class. We had about an hour before the actual judging started so we delighted in showing those brave souls all those little crevices where the judges would find those itsy-bitsy micro spots of dirt when their metacarpals seem to collapse during the actual judging into nano-size proportions enabling them to go where no finger has ever gone before! It was fun. I hope to see all those novices at the Halloween concours - there shouldn't be a particle of grime on their cars - right?

The games, brats and hot dogs were great. John is still hoping to find a way to Rockford for some more of those fantastic potato chips. (Anyone in our reading audience - feel free to send John his care package - he'll love you for it!!)

At days end gifts were handed out to everyone - there were even "shame gifts" for those that didn't enter the concour- guess who got one of those! John said it reminded him of one big family reunion.

Kudos to Rip and Linda Patterson and Bill Garvey for all their hard work -and of course to Wayne Potter for providing the location. We'll be back next year.

Dodie Mueller



Fun and games among...



The beautiful Porsches



Our gracious host, Wayne Potter  
(2nd from right)



The local Dirty Dozen, (R to L) Frank Wagner,  
Pete Brink, Ron Starkey, Mike Holzer



Hard working concours winners

## POTTER'S PICNIC CONCOURS RESULTS

### Class A

Dale Moody	272 T A
Dan Gallagher	248

### Class B

Robert Gummow	223.8 T
Howard Yefsky	215.0 T
Chuck Will	212.0 T
Bill Garvey	200.7
Art Metzger	196.75
Mark Wilwerth	182.3
V. Wm. Frazier	172.8

### Class C

Andy Zann	160.5 T
Bruce Janacek	152.0 T
Wayne Potter (356)	142.0
Wayne Potter (912)	126.0

### Class D

Ron Peterson	132 T
Frank Wagner	126 T
Gordon Govalet	116 T
Myron Walters	109
Peter Brink	107
Jim Harper	106
Harold Beach	99
M.J. Hutton	89

### Novice Class

Jim Jacisin	200 T
M.C. Phillips	197 T
Chad Whitman	118 T

### People's Choice

TIE	
Dan Gallagher	14 Votes
Bill Garvey	14 Votes

Judges: Bruce Janacek, Robert Gummow, Chuck McKay, Neiland Pennington, Ron Peterson, Wilma White, Dan Gallagher, Jim Harper, Howard Yefsky, Bill Garvey, Dale Moody, Art Metzger.

John Bohlander

# PERFECT WAX



MATRIX 120 N. Oak Park Avenue, Suite 202 Oak Park, Illinois (708) 386-0383

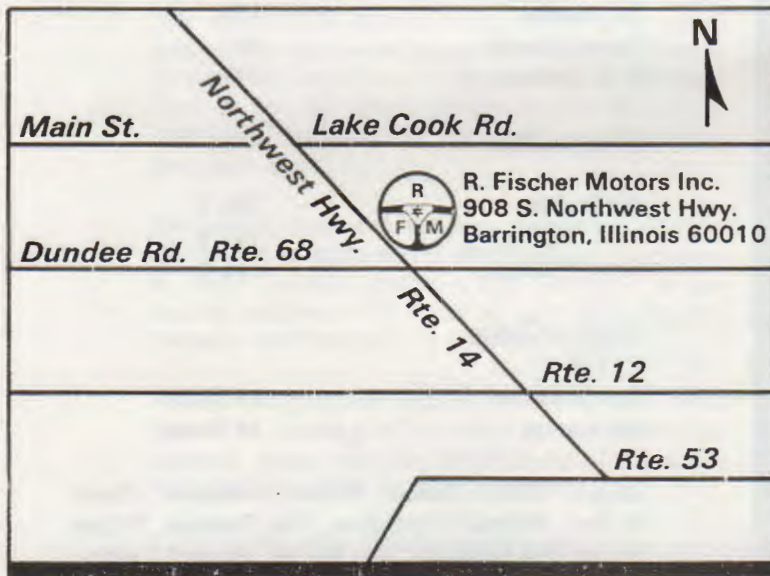

 *R. Fischer Motors Inc.*

Specializing in repair of

Porsche ■ Mercedes Benz  
BMW ■ Volkswagen ■ Audi

■  
30-Year Factory-Trained Technicians

■  
Competition Performance Service

■  
Modifications on Suspension and Engines  
Featuring Hunter Wheel Alignments

■  
*R. Fischer Motors Inc.*

908 Northwest Highway  
Barrington, Illinois 60010  
(708) 304-8822/8823

Weekdays 8:00 a.m.-5:00 p.m. ■ Saturday 8:00 a.m.-1:00 p.m.

# ELKHART II REVIEW

If you were there, you experienced a new look at a Road America weekend. If you didn't make it, you missed an inaugural tradition. I think we can sum up the two days as the best that could have been ordered. We even had Gallagher weather. Saturday was warm but partly cloudy, and Sunday was clear and in the high seventies. The track was fast and as clean as a concour winner. Needless to say, the drivers had an absolute ball!

We had a turnout of about fifteen kids and the bike rally went well with everyone huffing and puffing. The hill took its toll in energy, but everyone made it easily. We'll have to make it tougher next time. The area just to the east of the concession stand was marked off for the racing course for big wheels, roller skate/blades and radio controlled cars. The kids spent Saturday setting up pylons for their desired course for practice. Sunday proved to be exciting with the different groups making it around the pylons, with the F40 Ferrari in the background.

Some of the comments by the kids, "I liked the bike rally" (Shayle Matsuda, Brandon and Ryan Law, Chase Kaplan). "I love the first trophy I've ever won" (Andrea Patterson). Ross Matsuda liked winning his first bike race. From all of the kids, "Finally, there is something for us to do." The second favored activity was winning rides in the exotic cars during the parade laps. They won raffle rides in the Lake Forest Sports Cars' F40 Ferrari, 911 convertible and coupe, Dan Bacin's NSX, Gallagher's 300SL, and Coachworks' E Class Special. The adults also won rides, but they were all holding their breath for a ride in the F40. With four half hour parade sessions, Sunday turned out to be a free for all with the kids standing in line to get a ride in anything

that came by. Rip Patterson was seen with three young passengers grinning from ear to ear.

The businesses that took part did a brisk business in selling all sorts of clothing, accessories and just plain stuff. Both Eurosports and Coachworks have signed up for next year. Lake Forest Sports Cars was the big attraction with their Formula Atlantic, an absolutely gorgeous Ferrari powered Lola, the F40, and three 911's, one a lightweight auto cross special, which was for sale. Rick Mancuso came up on Sunday to offer the assistance of his assistants to the participants who had minor problems. LFSC will participate with our events next year offering even more assistance to the drivers with "fixable" problems--no engines rebuilds at the track please.

Ah, the swap meet. A few people showed up for the swap meet including myself with my old stuff. I was able to sell a slightly used set of Ferodo pads and bought a set of 914 tail light lenses. My six year old son, Ross and Terryl Johnson haggled over his Turbo Porsche peddle car and mini mountain (hill) bike. Both came out smiling. This was the first time Ross had ever haggled and you should have seen his smile--couldn't make his face wider. This could be a great way to get rid of old stuff and get reasonably priced used stuff. I hope you members can take advantage of this next year.

Thanks to Harriett Bauman, Shirley Cook, Gene D'Andrea, Val Harris, Russ Iser, Pete Kaplan, John Laidlaw, Bob Law, Laura Pichler, Glen Sapa, Roger Vale, Doris Voce for their assistance in making this such a success. A special thanks also goes out to the spouses and companions of the Core team.

ELKHART II FAMILYFEST



The crew from Lake Forest Sports Cars



Our friends from Emmons Coachworks



John Laidlaw - The Mintex man



Putting the family to work



Roller skating among the pylons



Event Chairman Hari Matsuda and Tech Chief Glenn Sapa

John Bohlander

---

## BEHIND THE SCENES

---

As I write this column on the first official Fall weekend recuperating from the flu (probably brought on by the always bizarre Chicago weather - 100 degrees one week and in the 30's the next), with most of the '91 driving season behind us, we turn our attention to some indoor sports. Our second annual concours face-off with the BMW Club this month, and the introduction of the 1992 968 at our November Tech Session. Our friends at Lake Forest Sports Cars have lots of fun activities planned surrounding this festive event. I'm curious to see first-hand the successor to the 944, although I have a warm spot in my heart for my '86.

Last month's plea for photos for future *Scene* covers brought a good response. We have some beautiful cars to feature in the months ahead.

We have a few surprises planned for the '92 *Scenes* - details to be announced. Stay tuned.

See you soon!

Doris

### ANNOUNCEMENT

I regret to announce the resignation of Cy Ling as Director effective at the last Board of Directors meeting on September 6th, 1991.

Cy has been a great asset to the Club and to the Board, first as Secretary last year and as Director this year. His advice and counsel have been invaluable to me.

We will most certainly miss him on the Board but we look forward to seeing him at the events!

I am happy to announce that Arnold Zann was appointed by the Board of Directors to succeed Cy as Director. He will fill the remainder of Cy's term - the balance of this year and 1992. We know he will do a wonderful job!

Debby

### WEDDING BELLS

Congratulations to Ilona Marcinkus and George Mueller who were married on September 29th. We wish them a long and happy life together!

## THE DRIVING PASSION

*via*  
**MOTO**

THE DRIVING PASSION



### Original Artwork & Limited Edition Prints

Koka, Owens, Cleworth, Hale, Motta, & many more

### Scale Models

Die-Cast & Resin Plastic  
Brianza, Onyx, Herpa, Creative Masters

### Distinctive Motoring Gifts, Accessories & Apparel

VIA MOTO LTD.  
Water Tower Place  
835 N. Michigan Avenue  
Chicago IL 60611-2201

Call for free brochure

312-943-1700 / 800-858-5995 / FAX 312-943-2474

## TURN ONE PARKING SPACE INTO TWO!

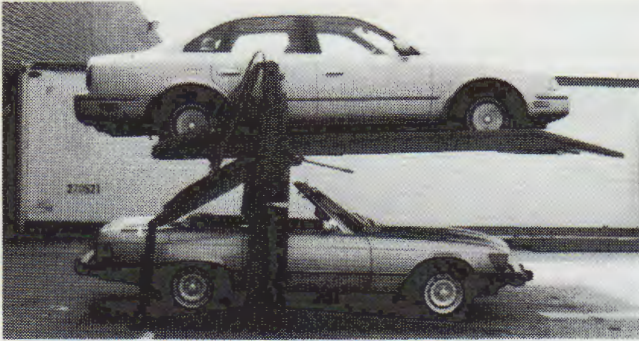

At last, an ideal way to transform an ordinary parking space into a multiple deck parking system, literally doubling your current capacity in seconds. It's called SPACE MAKER—an innovative product that actually pays for itself.

Developed to handle all types of passenger cars and light trucks, it has virtually unlimited residential and commercial applications. SPACE MAKER is a hydraulic steel platform designed to lift a vehicle into the air and lock it firmly and safely into place, thus allowing another vehicle to park directly beneath the first. It can be installed on any level surface—indoor or out—with no excavation, costly site preparation or increased taxes.

### OUTSTANDING FEATURES:

- 20-Year Track Record
- Safe and Easy To Operate
- Increases Your Parking Space And Income
- Leasing Or Financing Available

Call 312/486-6900 for complete information and a demonstration!



**Mid-American Elevator Co., Inc.**

820 N. Wolcott Ave., Chicago, IL 60622 • 312/486-6900 • Fax 312/486-2438



844 LIBERTY DRIVE  
LIBERTYVILLE, ILLINOIS 60048  
(708) 367-8837

PORSCHE PERFORMANCE TUNEUPS,  
MODIFICATIONS, ALIGNMENTS  
AND ENGINE DYNAMOMETER SERVICES.  
SPECIALIZING IN 911, CARRERA  
AND TURBO.



Authorized Dealer

RUF Appointed Sales & Service

# Body Werks of Barrington

For the Finest in  
PORSCHE, MERCEDES and BMW  
Work and Painting

DESI VINCZEN • 126 Cook Street • Barrington, IL  
381-9144

---

# THE MART

---

## ● FOR SALE - PORSCHE

911 Slantnose Turbo #WPOJBOGS050701, factory authorized car, black/black, 23K mi., all options, pristine condition. Very fast, very rare 182MPH car. \$65,000. Call Randy (708)202-0999 days, (312)944-6540 eves.

1986 911 factory Turbo-look Carrera coupe, Guardsman Red/Black, 43K mi., Blaupunkt equalizer system, sheepskins, hand-painted crests, bra, 16" wheels, halogen lights, no winters/smoke, garaged, \$35,000. Jim Knupp (708)729-4865 eves.

1984 911 White/Black interior, 5 speed, sunroof, A/C, L/R power mirrors, Lexan bra, sport suspension, new A008s, gold BBS look wheels, factory alarm, 66K mi., stored winters, excellent condition. \$8,900. Doug Hirt (517)351-5785 days, (517)6-944-928 eves.

1980 928, Silver with Black leather interior, 5 speed, Ungo box, bra-cover, recent mechanical upgrades. So you missed the '91 Parade; there's still time to travel first class to the 1992 Parade (San Diego). Clean and fast, no reasonable offer refused. Any offer below \$15,500 is unreasonable. Bruce Janecek (708)354-1901 weekdays, (708)361-8421 other times.

1973 911T Targa, Black/Tan, body is in real good shape, solid car, new Sony pull-out stereo, good brakes & tires, MSD ignition, Weber carbs, fuel pressure monitor, interior is original. Tim Billmack (815)459-4721 eves.

1960 356B Super 90 coupe, Ruby red turnkey vintage racer. Disc brakes, fuel cell, twin oil coolers, deep sump with skid plate, accusump. '73 Carrera racing seats, 6-point stand 21 harness. Skirmants motor. Street driveable, highly reliable, Bursch street/racing exhausts. Jim Knupp (708)729-4865 eves.

## ● FOR SALE - PARTS

**WHEELS:** Set of 4 7x16, black & silver with painted centers, brand new, never used. Will fit '84 or earlier 944, 924 or 911. \$500 OBO. Doris Voce (708)462-0451.

## ● FOR SALE - OTHER

1988 Volkswagen Fox, 2 door station wagon, silver, 4 speed with A/C, alloy Jetta wheels with Goodyears, Quantum seats, Blaupunkt AM/FM tape. This autobahn "shooting brake" is a dependable, economical, daily runner and/or ghetto cruiser. \$4,450. Bruce Janecek (708)354-1901 weekdays, (708)361-8421 other times.

Racing in your own backyard. Corner one at scenic Ginger Man Lake Race Track, a new track for Midwest club racing in Sister Lake, Michigan. 4 bedroom, 2 bath home with 11 car garage on 2 acres. Info: Daniel Schnitta (616)471-9663.

1955 Porsche 356 Speedster, Replica. Established import repair facility offers professionally built, turn-key car. You choose engine, performance options, gauges, accessories, color, interior. Visually satisfies nostalgia of period, yet features modern engine, running components, suspension. 12 Mo/12,000 Mi. warranty. Save your classic, have fun driving this one daily. Base price \$14,500. John Swift, Swift Motor Car Company, Inc. Anniston, AL (205)237-5409.



Does your driveway look like a used car lot?

Is your toy, the one that you drive on perfect days only, resting in a cozy garage while your daily transportation is outside gathering snow?

As the exclusive dealer for CAR-LIFT, manufactured by HARDING-AFG, INC. we have the solution to your problems.

If you have 9 feet ceiling clearance in your garage we can install the CAR-LIFT, to handle two standard size cars, without any modifications. If you don't have the necessary clearance, we can modify your garage ceiling height without major structural changes to your garage. Your total cost, including the CAR-LIFT, will be much lower than expanding your existing garage.

The CAR-LIFT, complete and installed (including shipping), less garage modifications, is only \$5450.00 plus tax.

HARDING-AFG CAR-LIFT has the exclusive feature that allows us to stack two cars totaling in height more than the ceiling height. All CAR-LIFT's are of galvanized steel construction to meet outdoor installation requirements as well as providing "Road Salt" drip resistance.

**NO FOUNDATION OR FLOOR PREPARATION REQUIRED.**

We can do a simple 3 hour installation or a custom installation to fit your needs. The HARDING-AFG CAR-LIFT is a heavy duty system constructed to meet specifications required for commercial use, but designed to fit residential requirements in size and appearance. There are 17,000 installations worldwide. HARDING-AFG is in its 21st year manufacturing car stacking systems.



**CIRCLE AFFILIATED SYSTEMS** is the exclusive dealer in your area. Please call us at 1-800-447-7410 or return the attached form for additional information.

**S**end me more information about the Car-Lift.

Name: \_\_\_\_\_

Address: \_\_\_\_\_

City: \_\_\_\_\_ State: \_\_\_\_\_ Zip: \_\_\_\_\_

Phone: (     ) \_\_\_\_\_

**CIRCLE AFFILIATED SYSTEMS, INC.**  
P.O. Box 1729, Palatine, Illinois 60078-1729  
1-800-447-7410 FAX (708)359-9218

***Nothing Even Comes Close!***

For Genuine PORSCHE® Parts...

***Get Your Winning Combination at***

***Jack Winters***

**HINSDALE MOTOR CARS**

***YOUR SATISFACTION IS OUR #1 PRIORITY!***  
*We Understand Your Needs! Our Inventory & Warehouse delivers the parts You need when You need them! We treat your order with the same priority of our own shop! Use the coupon below for an additional bonus from your source for genuine Porsche parts—*  
**JACK WINTERS!**

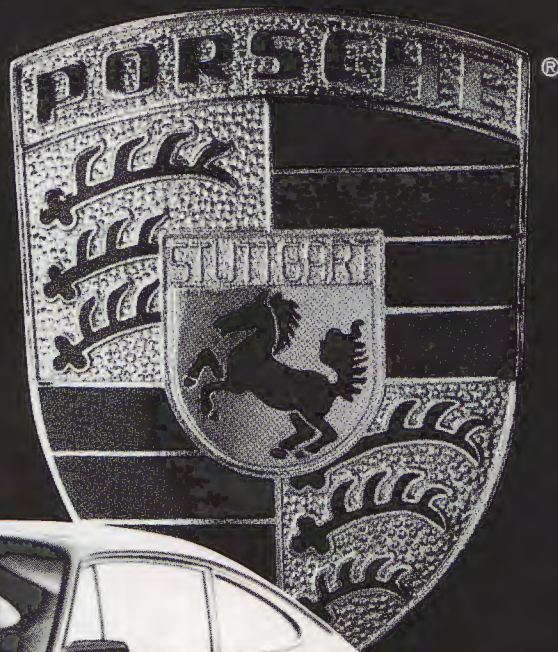

*Call Jeff Martin, Parts Manager*

*For Immediate Assistance.*

- **PORSCHE®** *Vintage* **SPECIALISTS**
- **COMPLETE ACCESSORY BOUTIQUE**
- **PARTS HOTLINE: (708)887-1010**
- **PARTS HOURS: Daily 7AM-5PM**
- **Sat. 9AM-1PM**
- **SERVICE HOURS: Daily 7AM-4:30 PM**

**PORSCHE CLUB** members enjoy a **10% DISCOUNT**  
on all parts purchases with proof of membership

**Take An Additional**

**5% OFF!**

**Any Order for Parts of \$250 or More!**

**PARTS HOTLINE: (708) 887-1010**

Coupon must be presented at time of purchase. 1 coupon per customer.

**Offer good through November 1, 1991.**

# HOT, FRESH AND...FAST!



## AMERICA'S 1ST HEART-HEALTHY PIZZA!

FRANCHISE OPPORTUNITIES AVAILABLE 1 708/655-1982

*"Best stuffed spinach in town."*

**Crain's Chicago Business**

*"Mouthwatering, to say the least!"*

*The Boston Globe*

*"One of the nation's top independents"*

**Pizza Today**

*Featured in the New York Times, USA Today, Bon Appetite, ELLE and others.*



2204 NORTH LINCOLN AVE. CHICAGO  
1504 NORTH NAPER BLVD. NAPERVILLE

75 EAST WACKER DR. CHICAGO  
1001 WEST BELMONT AVE. CHICAGO

940 WESTPORT PLAZA ST. LOUIS, MO.